

Article number: 2314450516

Description: E+G polyamide wheel
RE.F8-125-RBL - loose wheel in polyamid

Measures

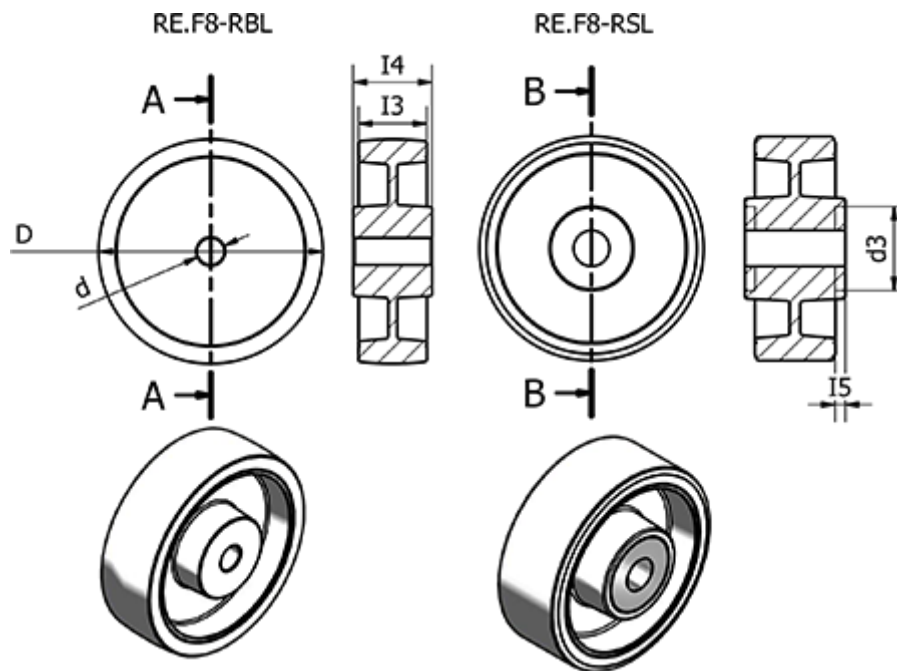

	= -	Rolling resistance (N) = 2000
Code	= 450516	Static load = 4500
d	= 125	Type = RE.F8-125-RBL
d3	=	Wight (g) = 230
Dynamic carrying capacity (N)	= 4000	
I3	= 38	
I4	= 44	
I5	=	